

Internal Hexagon Prosthetic Options

MIS[®] | MAKE IT SIMPLE

NOT FOR USE IN THE USA AND CANADA

Products may not be available in some regulated markets. Please contact your local Dentsply Sirona sales office for current product assortment and availability.

The MIS Quality System complies with international quality standard ISO 13485: 2016 - Quality Management System for Medical Devices, with Medical Device Directive 93/42/EEC, and with EU Medical Device Regulation MDR 2017/745. Please note, that not all products are registered or available in every country/region.

IFUs for MIS products may be found at: <https://ifu.mis-implants.com>. Adobe Acrobat is required to view the IFU file on the website. This software may be freely downloaded from the Adobe website.

Table of Contents

Implant Dimensions P. 6 - 7	Prosthetic Options Listed by Healing Caps P. 8 - 9	Healing Caps P. 10 - 12	Impression Coping P. 13 - 14	Temporary Restoration P. 15 - 17
---------------------------------------	--	-----------------------------------	--	--

○ Temporary Cylinders

Screw-Retained Restoration

P. 18 - 23

- Multi-Unit System
- Plastic Cylinders

Digital Restoration

P. 24 - 29

- EZ-Base System
- Ti-Bases
- Digital Model Analogs
- Scan Posts
- Titanium Blanks

Cemented Restoration

P. 30 - 39

- Cementable Abutments
- CPK

Overdenture

P. 40 - 45

- LOCKIT System
- OT-Equator Kits
- Ball Attachment System

Prosthetic Screws and Drivers

P. 46 - 47

Implant Dimensions: SEVEN

Narrow
Platform



Standard
Platform



Wide
Platform

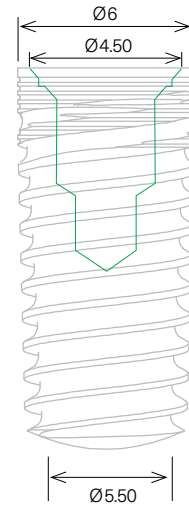
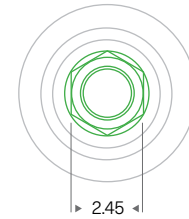
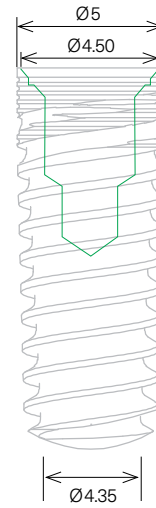
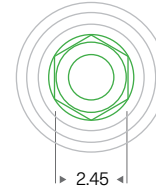

Implant Dimensions: M4

Narrow
Platform



Standard
Platform

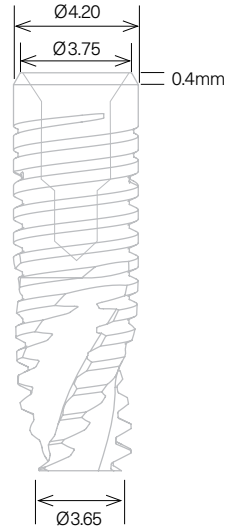
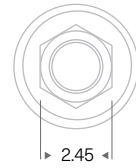

Wide
Platform

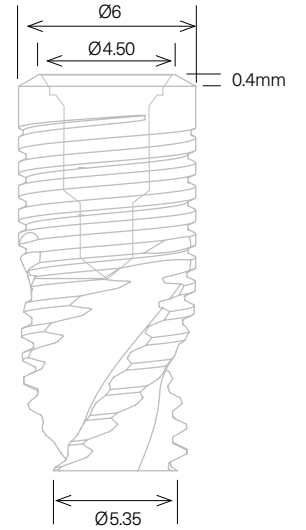
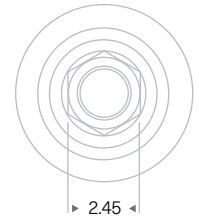
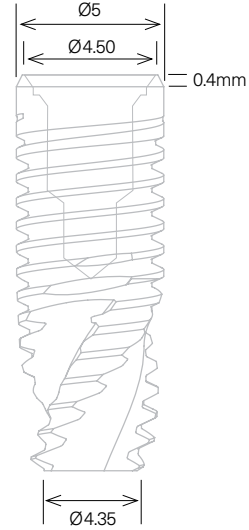

ALL PLATFORMS

Prosthetic Options Listed by Healing Caps

Each column lists the different heights of healing caps and corresponding prosthetic options. **Bold** item numbers indicate the products shown in the images above.

*Image is for illustration only. (2mm height closed tray impression coping presented. Not available in 3mm).

1. Narrow Platform

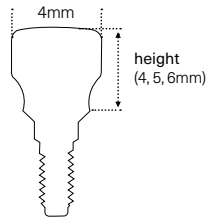

2. Standard Platform

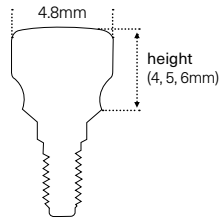

3. Wide Platform

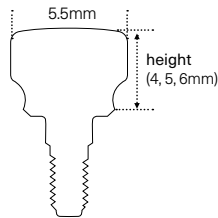

Healing caps	Impression coping, open tray	Impression coping, closed tray	Cemented options	Digital options
--------------	------------------------------	--------------------------------	------------------	-----------------

or

or

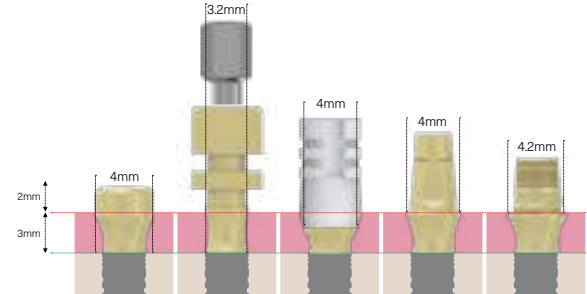

Gingival heights 2, 3, 4mm	MH-N0440	MN-IO401	MN-ITC30*	MK-NPC62 MN-MC102 MN-AT102 MN-AT202	
	MH-N0540			MK-NPC63	MN-TBC30 MN-FTB30
	MH-N0640			MK-NPC64	

Healing caps	Impression coping, open tray	Impression coping, closed tray	Screw retained options	Cemented options	Digital options
--------------	------------------------------	--------------------------------	------------------------	------------------	-----------------

or or or

Healing caps	Impression coping, open tray	Impression coping, closed tray	Screw retained options	Cemented options	Digital options
--------------	------------------------------	--------------------------------	------------------------	------------------	-----------------

or or or

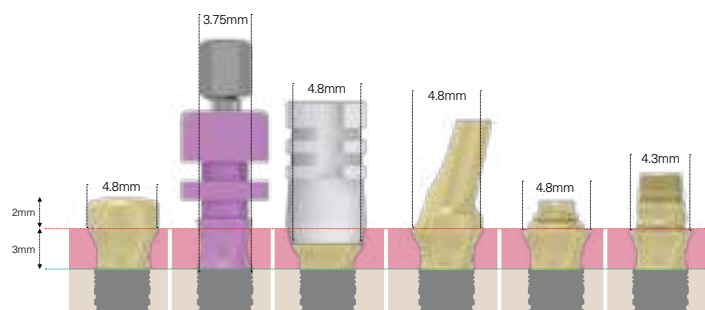

Gingival heights 2, 3, 4mm	MH-S0448	MN-IO481	MD-ITC30*	MK-CPC62 MD-MC102 MD-AT152 MD-AT252	MA-SC248	
	MH-S0548			MD-AT153 MD-AT253 MK-CPC63	MA-SC348	MD-TBC30 MD-FTB30
	MH-S0648			MK-CPC64	MA-SC448	

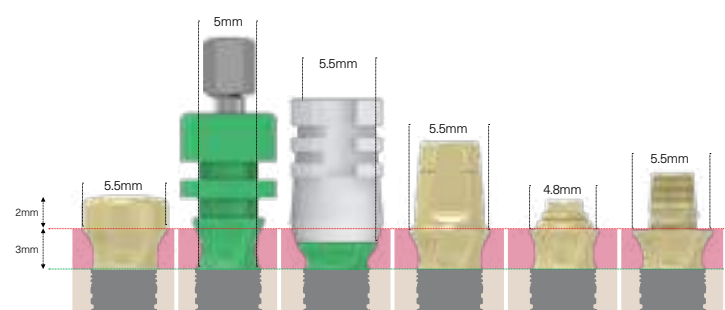

Gingival heights 2, 3, 4mm	MH-W0455	MN-IO551	MW-ITC30*	MK-WPC62 MW-MC102 MW-AT152		
	MH-W0555			MK-WPC63	MA-WC348	MW-TBC30 MW-FTB30
	MH-W0655			MK-WPC64		

Healing Caps Narrow Platform

Tightening torque: 20-25 Ncm

HEIGHT

SEVEN/M4
H2

SEVEN/M4
H3

SEVEN/M4
H4

SEVEN/M4
H5

SEVEN/M4
H6

SEVEN/M4
H8

Thin, Ø3.3



MH-N2330



MH-N3330



MH-N4330



MH-N6330

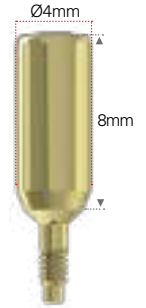

MH-N8330

Standard, Ø4

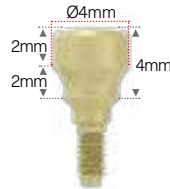

MH-N0440

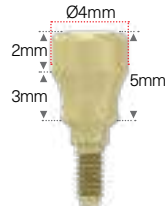

MH-N0540

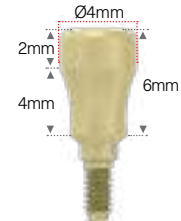

MH-N0640

Anatomic, Ø4.3



MH-52330



MH-53330

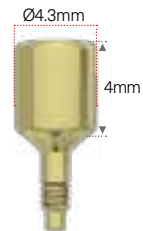

MH-54330



MH-55330

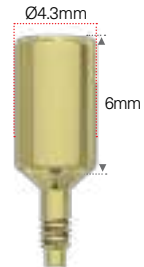

MH-56330

Healing Caps Standard Platform

Tightening torque: 20-25 Ncm

HEIGHT

SEVEN/M4
H3

SEVEN/M4
H4

SEVEN/M4
H5

SEVEN/M4
H6

Thin, Ø4



MH-03375



MH-04375



MH-05375



MH-06375

Standard, Ø4.8



MH-A3375



MH-A4375



MH-A5375



MH-A6375

Standard, Ø4.8



MH-S0448



MH-S0548



MH-S0648

Anatomic, Ø5.5



MH-53375

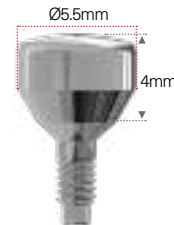

MH-54375

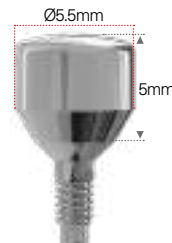

MH-55375

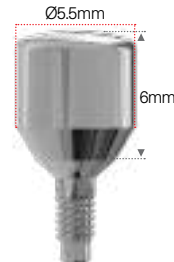

MH-56375

Healing Caps Narrow Platform

Tightening torque: 20-25 Ncm

HEIGHT

Standard, Ø5

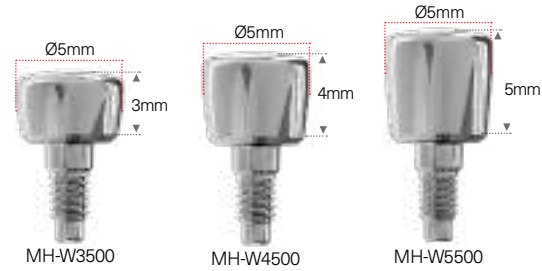

Standard, Ø5.5

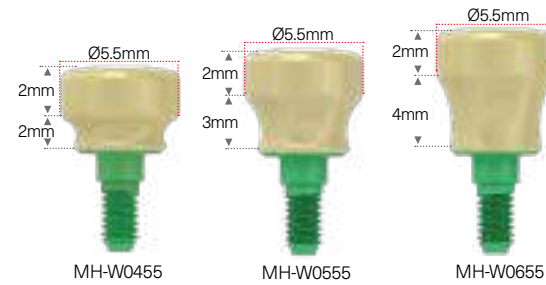

Anatomic, Ø6.5

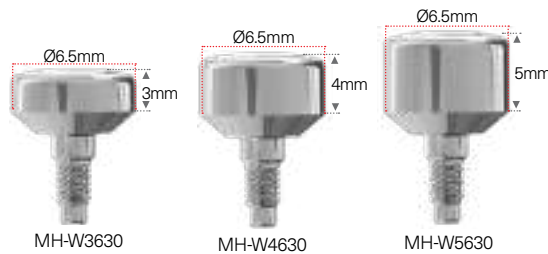

SEVEN/M4
H3

SEVEN/M4
H4

SEVEN/M4
H5

SEVEN/M4
H6

Impression Copings Open tray

Tightening torque: 20-25 Ncm

PLATFORM

SEVEN/M4
NP

SEVEN/M4
SP

SEVEN/M4
WP

Impression coping

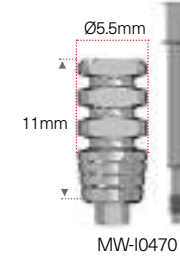
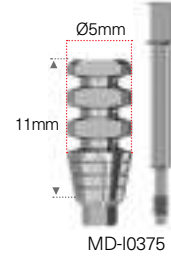
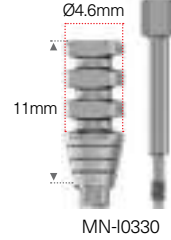

Impression coping

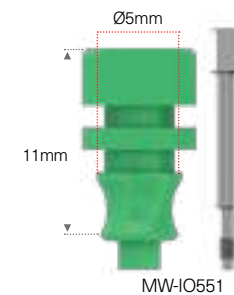
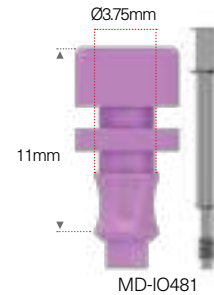
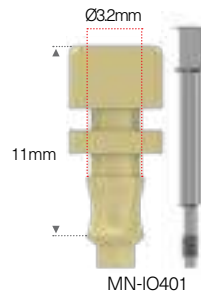

Implant analog,
open/closed tray

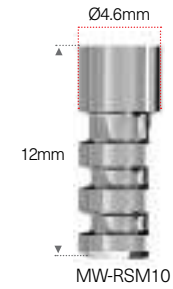
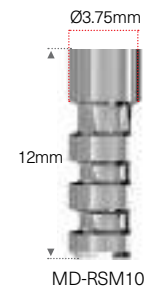
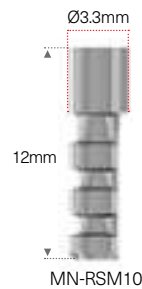

Impression Copings

Closed tray

Tightening torque: 20-25 Ncm

PLATFORM

SEVEN/M4
NP

SEVEN/M4
SP

SEVEN/M4
WP

Impression coping

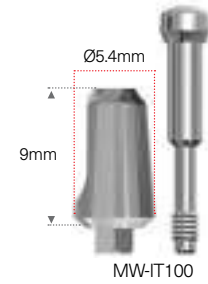
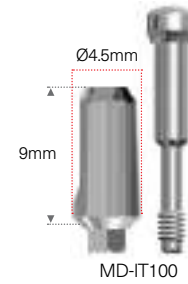
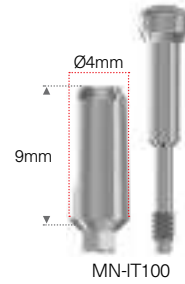

Impression coping set

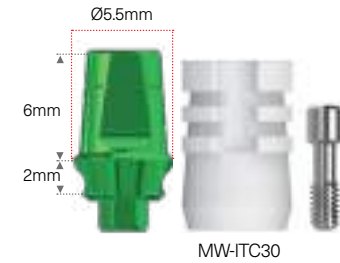
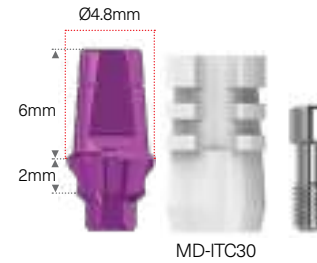
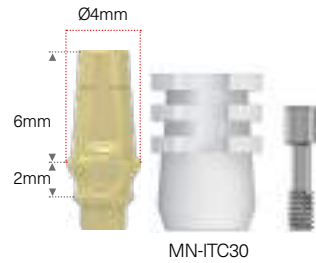
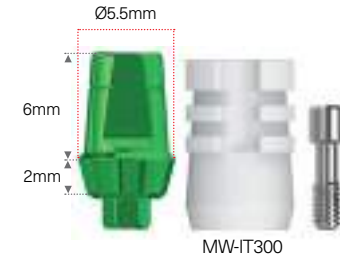
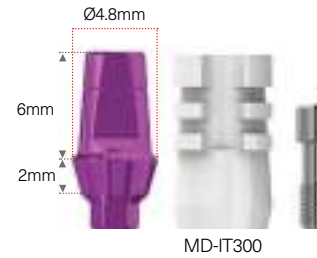

Press fit

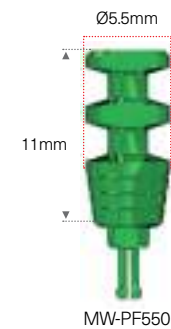
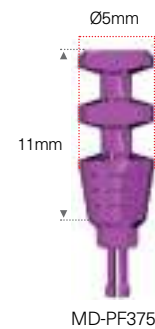

Temporary Restoration

Temporary Plastic Cylinders

Anti rotation

Tightening torque: 20-25 Ncm

PLATFORM

Narrow profile temporary plastic abutment, H1

Temporary plastic abutment, H1

Temporary plastic cylinder, H2.5

SEVEN/M4
NP

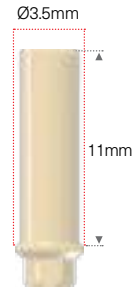

MN-TPA12

SEVEN/M4
SP

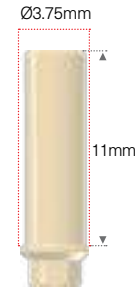

MD-TPA12

SEVEN/M4
WP

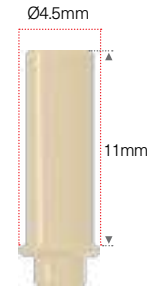

MW-TPA12

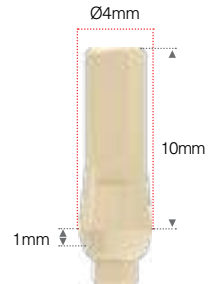

MN-TPA10

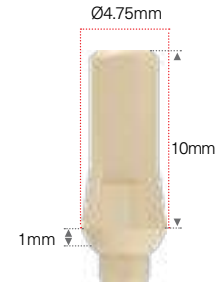

MD-TPA10

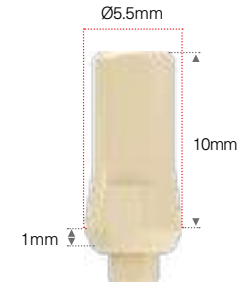

MW-TPA10

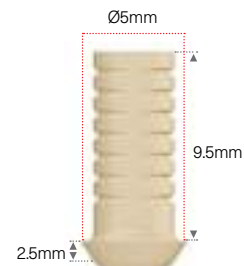

MD-TPH50

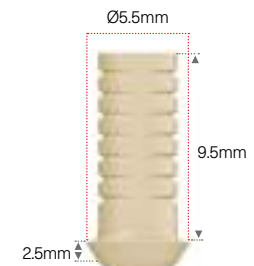

MW-TPH50

Temporary Restoration

Temporary Cylinders

Free rotation

Tightening torque: 20-25 Ncm

PLATFORM

SEVEN/M4
NP

SEVEN/M4
SP

SEVEN/M4
WP

H1

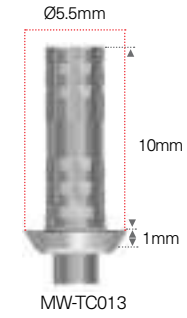
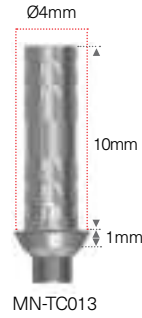

H2

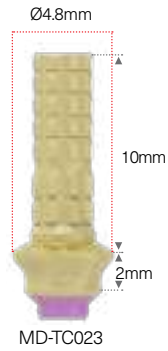
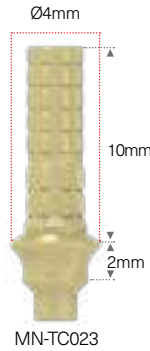

H3

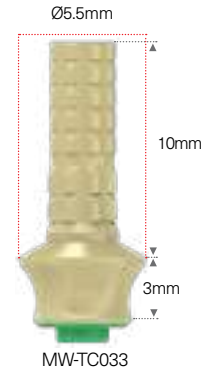
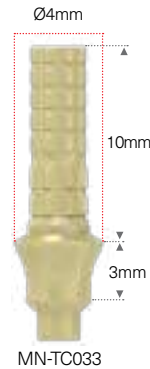

Temporary Restoration

Temporary Cylinders

Anti-rotation

Tightening torque: 20-25 Ncm

PLATFORM

SEVEN/M4
NP

SEVEN/M4
SP

SEVEN/M4
WP

H1

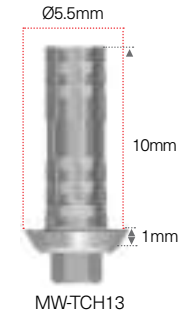
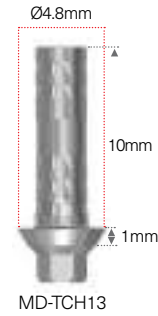
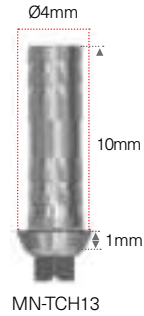

H2

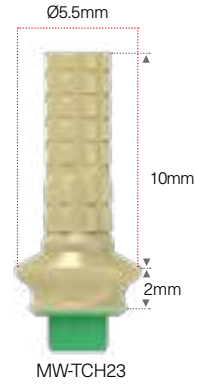
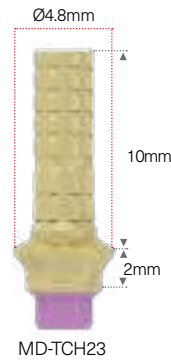

H3

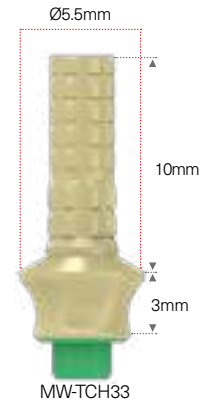
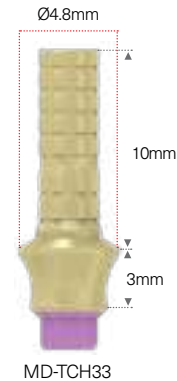
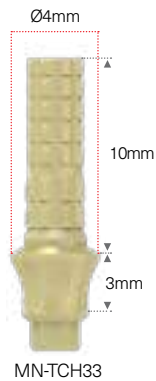

Screw Retained Restoration

Multi-Unit System

Tightening torque: 30 Ncm

PLATFORM

SEVEN/M4
NP

SEVEN/M4
SP

SEVEN/M4
WP

H2



MA-NC248



MA-SC248

H3



MA-NC348



MA-SC348



MA-WC348

H4



MA-NC448



MA-SC448

H5



MA-WC548

Screw Retained Restoration

Multi-Unit System

Tightening torque: 30 Ncm

PLATFORM

SEVEN/M4
NP

SEVEN/M4
SP

SEVEN/M4
WP

H1



MA-N1480



MA-S1480



MA-W1480

H2



MA-N2480



MA-S2480

H3



MA-N3480



MA-S3480



MA-W3480

H4



MA-N4480

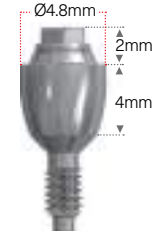

MA-S4480

H5

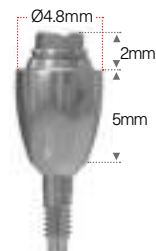

MA-N5480



MA-S5480

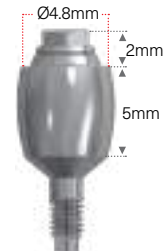

MA-W5480

Screw Retained Restoration

Multi-Unit System

Angulated abutments, 17°

Tightening torque: 20 Ncm

PLATFORM

SEVEN/M4
NP

SEVEN/M4
SP

SEVEN/M4
WP

H1



MA-NO171



MA-SO171



MA-WO171

H2



MA-NO172



MA-SO172



MA-WO172

H3



MA-SO173



MA-WO173

Screw Retained Restoration

Multi-Unit System

Angulated abutments, 30°

Tightening torque: 20 Ncm

PLATFORM

SEVEN/M4
NP

SEVEN/M4
SP

SEVEN/M4
WP

H1



MA-NO301



MA-SO301



MA-WO301

H2

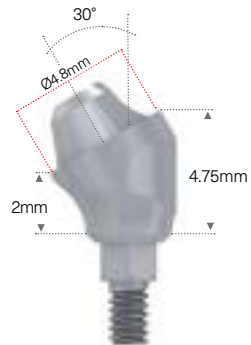

MA-NO302

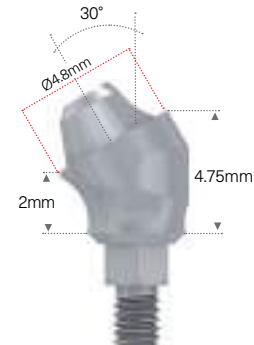

MA-SO302

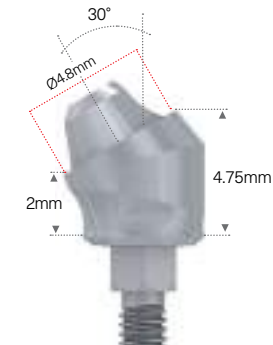

MA-WO302

H3

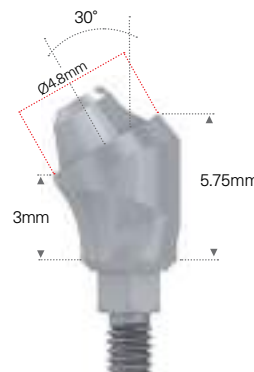

MA-SO303

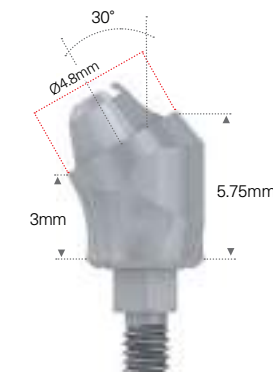

MA-WO303

Multi-Unit System Components

Healing cap

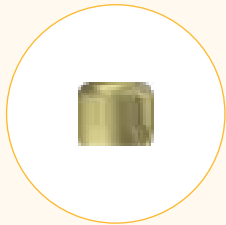

MU-H4480

Analog

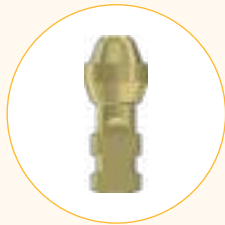

MU-RSM48

Impression coping,
open tray

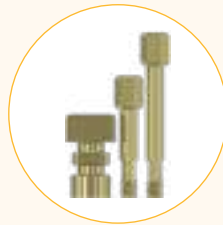

MU-I0480

Impression coping,
closed tray



MU-IT480

Temporary cylinder



MU-TO480

Plastic cylinder



MU-CP048

Gold bar coping abutment



MU-BGC48

Cementing cap
(New design)



MU-CC481

Cementing cap



MU-CC480

Scan Post



MU-SP102

Digital model analog



MU-MAN10

Screw Retained Restoration

Plastic Cylinders

Free rotation

Tightening torque: 30 Ncm

PLATFORM

SEVEN/M4
NP

SEVEN/M4
SP

SEVEN/M4
WP

Gold plastic cylinder

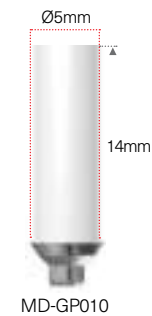

Plastic cylinder

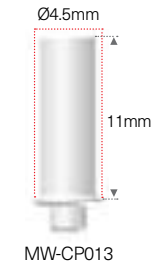
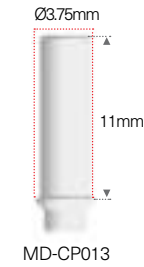

CoCr plastic cylinder

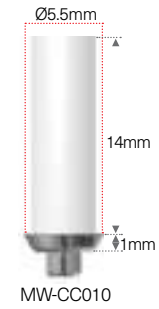
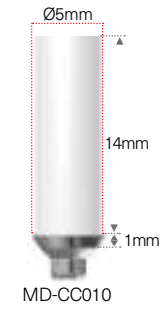

Wide profile plastic cylinder

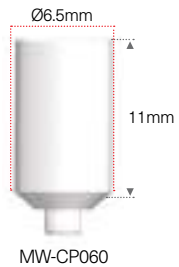
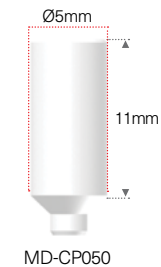

Screw Retained Restoration
Plastic Cylinders
 Anti-rotation

Tightening torque: 30 Ncm

PLATFORM

SEVEN/M4
 NP

SEVEN/M4
 SP

SEVEN/M4
 WP

Gold plastic cylinder

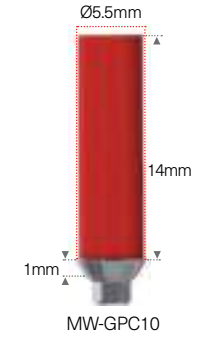
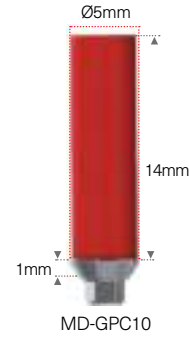
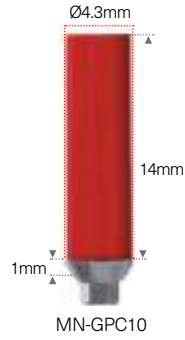

Plastic cylinder

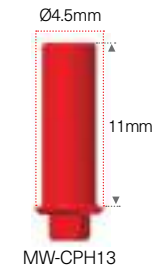
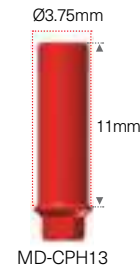
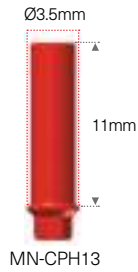

CoCr plastic cylinder

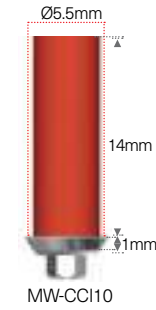
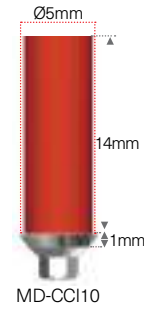
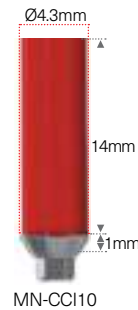

Wide profile plastic cylinder

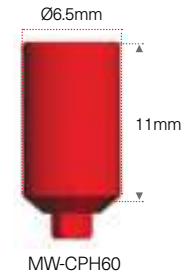
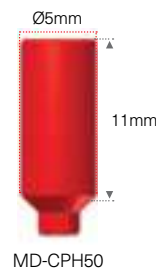

Digital Restoration

EZ-Base System

Tightening torque: 25 Ncm

PLATFORM

H1.5



SEVEN/M4
NP



SEVEN/M4
SP



SEVEN/M4
WP



EZ-Base System Components

Ratchet key for angled screw channel

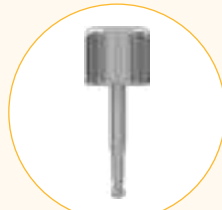

MT-ELR10 - Long
MT-ESR10 - Short

Motor key for angled screw channel

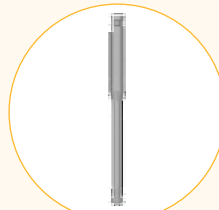

MT-ELM10 - Long
MT-ESM10 - Short

EZ-Base prosthetic screw

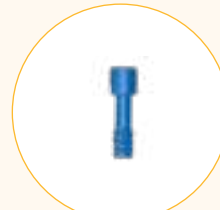

MN-E0160 - NP
MD-E0220 - SP



A unique screw and driver tip design enable extreme angulation and a wide insertion path.

Digital Restoration

Ti-Base

Anti-rotation

Tightening torque: 30 Ncm

PLATFORM

SEVEN/M4
NP

SEVEN/M4
SP

SEVEN/M4
WP

H0.5

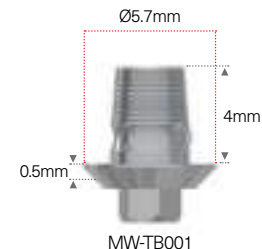
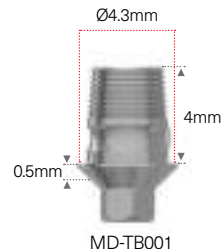

H1.5

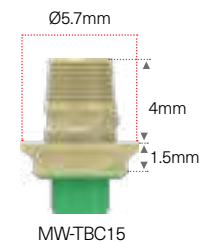
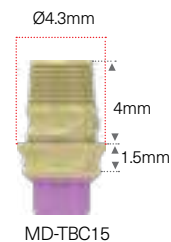
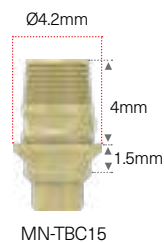

H3

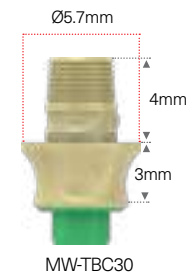
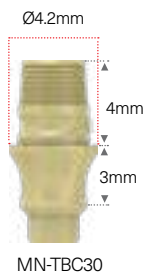

H0.5

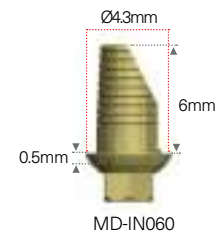
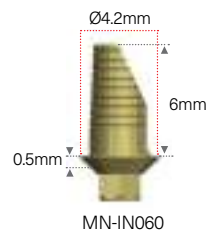

Digital Restoration

Ti-Base

Free-rotation

Tightening torque: 30 Ncm

PLATFORM

SEVEN/M4
NP

SEVEN/M4
SP

SEVEN/M4
WP

H0.5

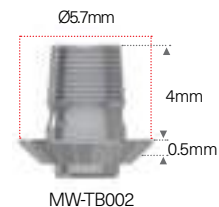
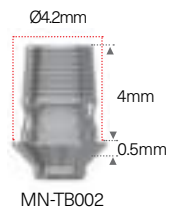

H1.5

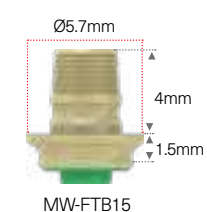
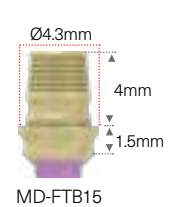
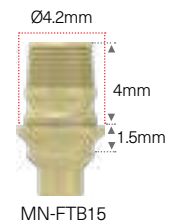

H3

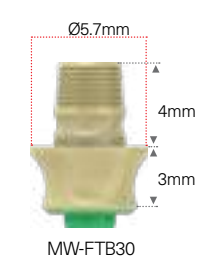
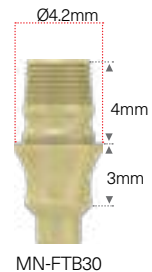

Digital Restoration
**Digital Model
Analog**

Tightening torque: 15 Ncm

SEVEN/M4
NP



SEVEN/M4
SP



SEVEN/M4
WP

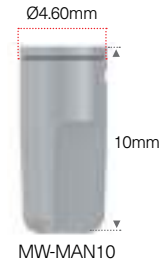

Multi-Unit

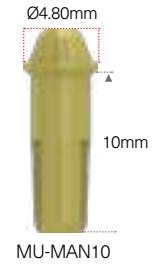

Digital Restoration
Scan Posts

Tightening torque: 20 Ncm

SEVEN/M4
NP



MN-SP102

SEVEN/M4
SP



MD-SP102

SEVEN/M4
WP



MW-SP102

Multi-Unit



MU-SP102

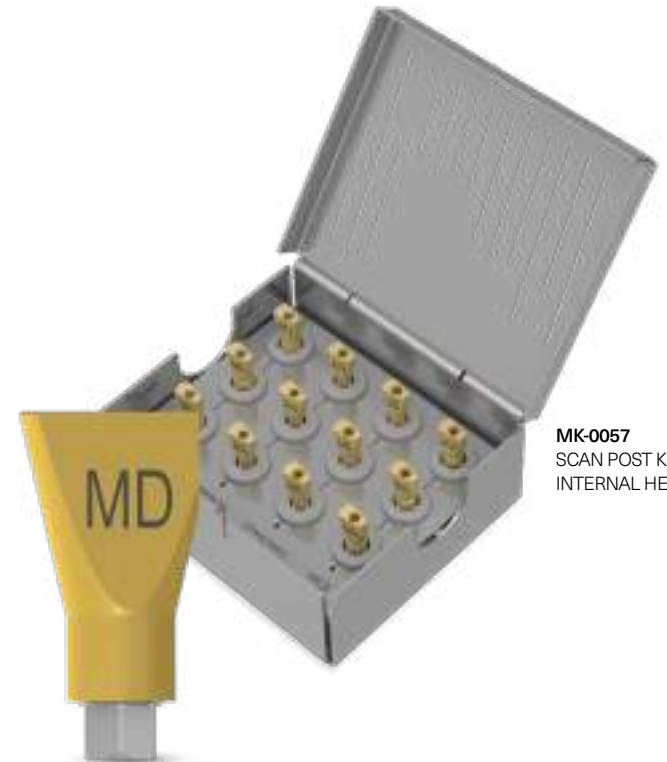

MK-0057
SCAN POST KIT,
INTERNAL HEX.

Digital Restoration
Titanium Blanks
 Anti-rotation

Tightening torque: 30 Ncm

PLATFORM

SEVEN/M4
 NP

SEVEN/M4
 SP

SEVEN/M4
 WP

Ø9

Ø9mm



MN-IB091

Ø9mm



MD-IB091

Ø9mm



MW-IB091

Ø12

Ø12mm



MN-IB121

Ø12mm



MD-IB121

Ø12mm



MW-IB121

Amann Girrbach, Ø12

Ø12mm



MN-AGT12

Ø12mm



MD-AGT12

Ø12mm



MW-AGT12

Milling analogs

Ø5



MN-MAB10

13.5mm

Ø5



MD-MAB10

13.5mm

Ø5



MW-MAB10

13.5mm

Cemented Restoration
**Cementable
Abutments**

Tightening torque: 30 Ncm

PLATFORM

SEVEN/M4
NP

10°

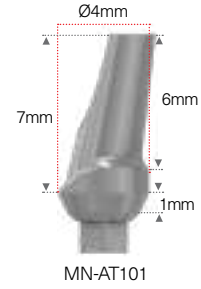
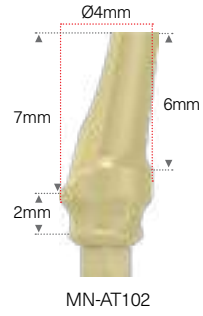

20°

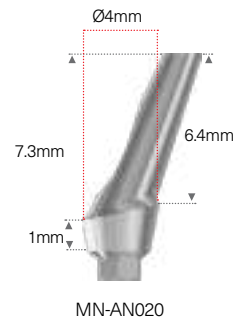
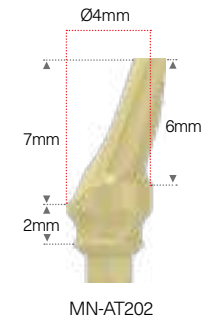

Cemented Restoration
**Cementable
 Abutments**

Tightening torque: 30 Ncm

SEVEN/M4
 SP

PLATFORM

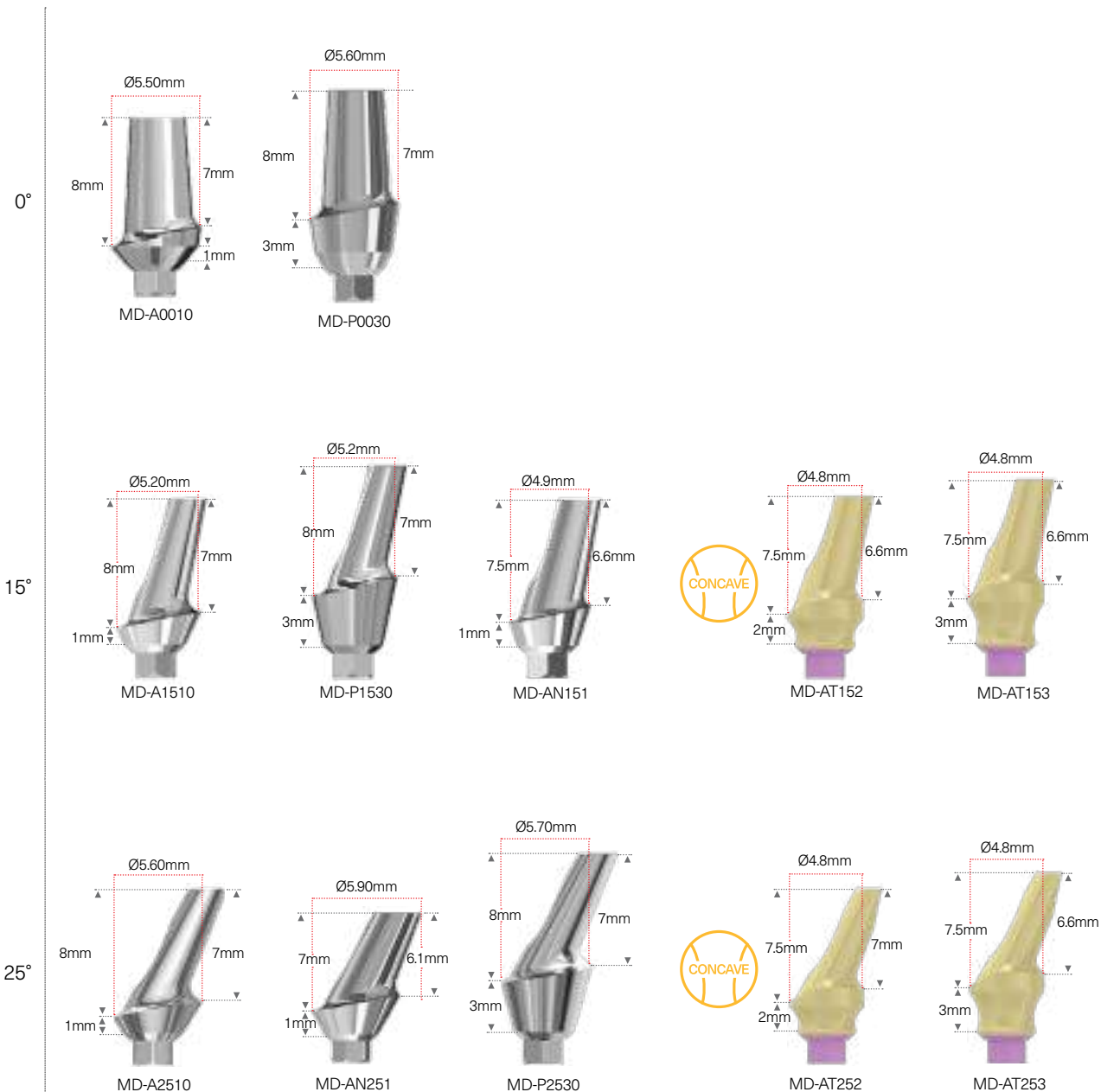

Cemented Restoration

Cementable Abutments

Tightening torque: 30 Ncm

PLATFORM

SEVEN/M4
WP

0°

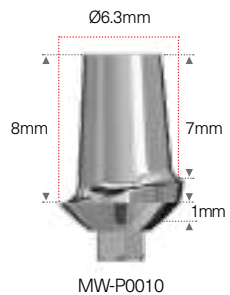

15°

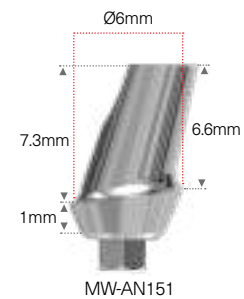
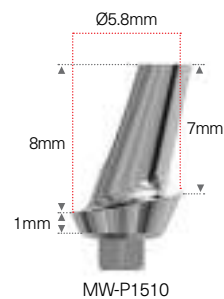
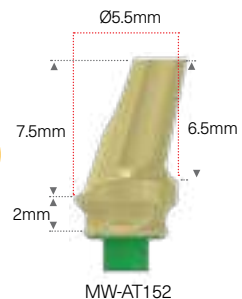

Cemented Restoration
Cementing posts

Tightening torque: 30 Ncm

PLATFORM

SEVEN/M4
NP

SEVEN/M4
SP

SEVEN/M4
WP

H1

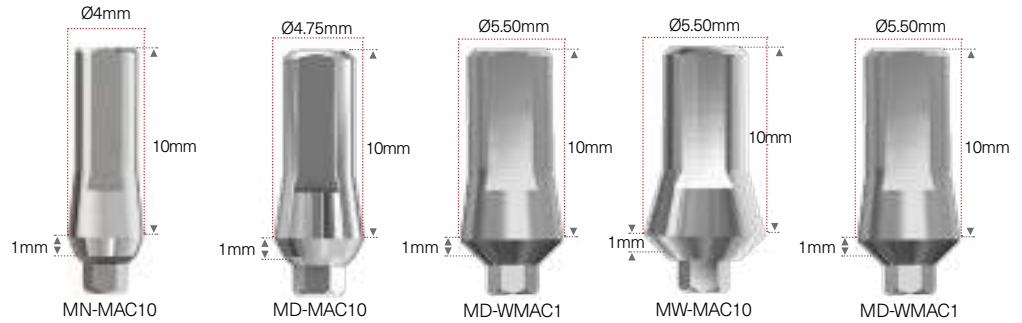

H1

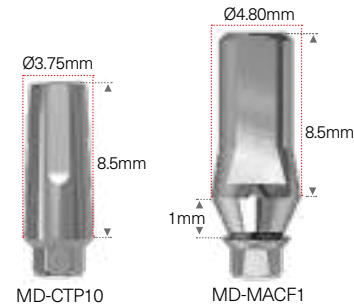

H2

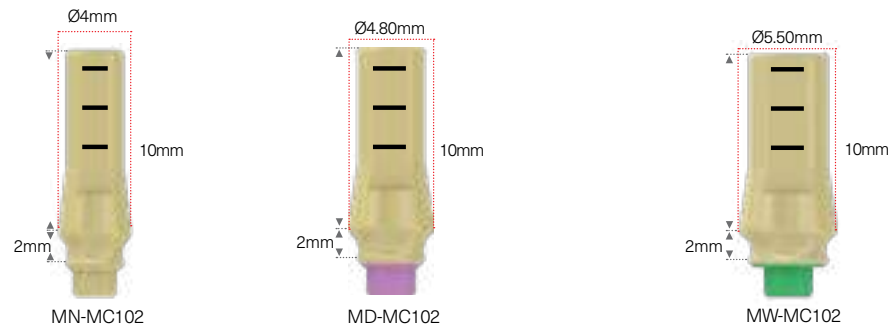

Cemented Restoration
**CPK -
 Transgingival
 Abutments**
 4mm Crown

Tightening torque: 30 Ncm

PLATFORM

SEVEN/M4
NP

SEVEN/M4
SP

SEVEN/M4
WP

H1

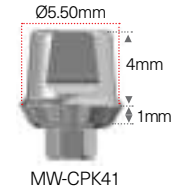
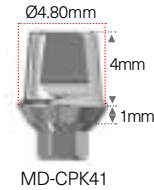
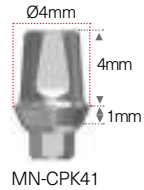

H2

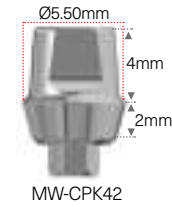
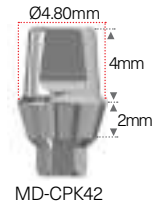
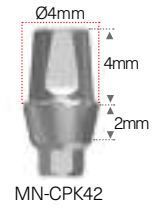

H3

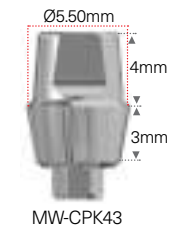
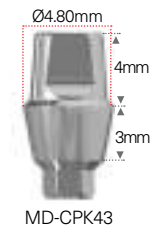
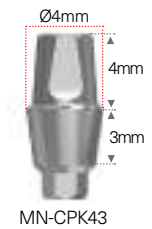

H4

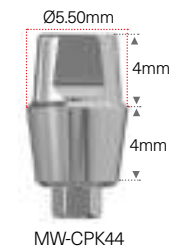
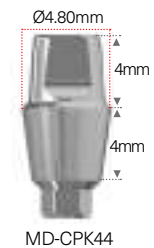
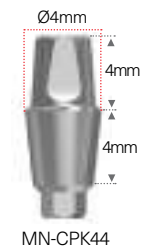

Cemented Restoration
**CPK -
 Transgingival
 Abutments**
 6mm Crown

Tightening torque: 30 Ncm

PLATFORM

SEVEN/M4
 NP

SEVEN/M4
 SP

SEVEN/M4
 WP

H1

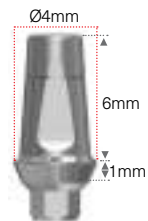

MN-CPK61

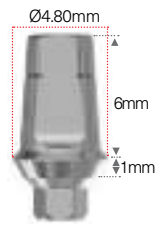

MD-CPK61

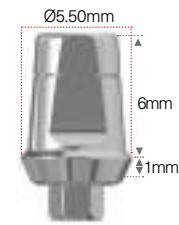

MW-CPK61

H2

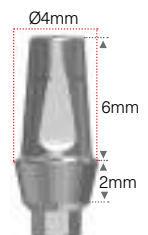

MN-CPK62

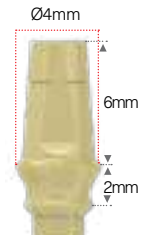

MN-CPC62

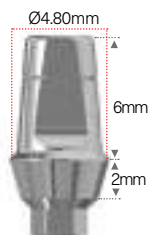

MD-CPK62



MD-CPC62

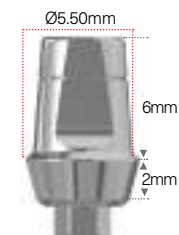

MW-CPK62

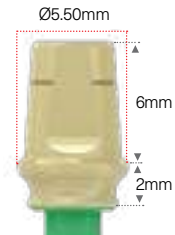

MW-CPC62

H3

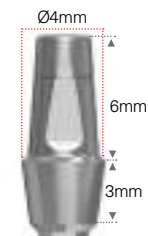

MN-CPK63



MN-CPC63

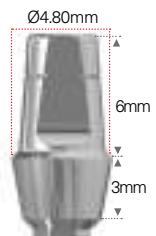

MD-CPK63



MD-CPC63

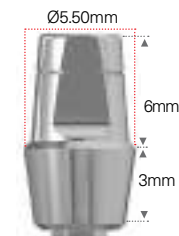

MW-CPK63

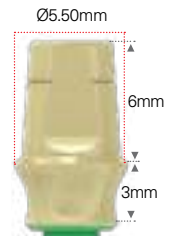

MW-CPC63

H4

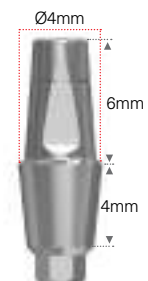

MN-CPK64



MN-CPC64

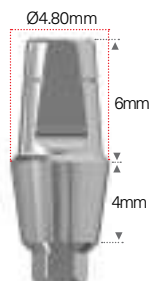

MD-CPK64

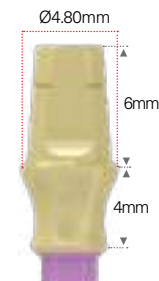

MD-CPC64

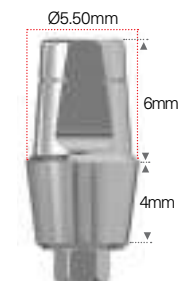

MW-CPK64

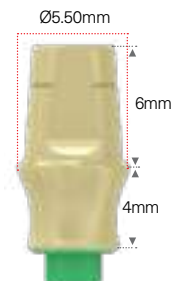

MW-CPC64

Cemented Restoration

CPK - Transgingival Abutments

8mm Crown

Tightening torque: 30 Ncm

PLATFORM

SEVEN/M4
SP

SEVEN/M4
WP

H1

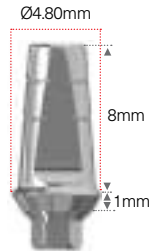

MD-CPK81

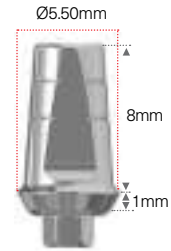

MW-CPK81

H2

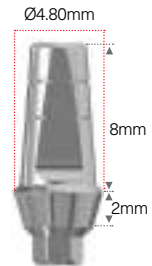

MD-CPK82

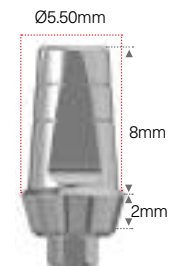

MW-CPK82

H3

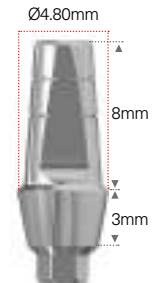

MD-CPK83

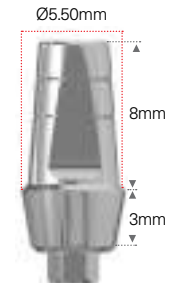

MW-CPK83

H4

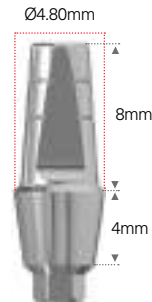

MD-CPK84

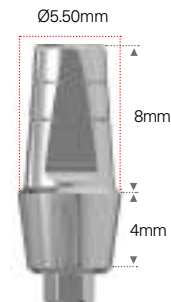

MW-CPK84

CPK abutments are also sold in kits.

MK-NPK41 ● Ø4, H=1, C=4
MK-CPK41 ● Ø4.8, H=1, C=4
MK-WPK41 ● Ø5.5, H=1, C=4

MK-NPK42 ● Ø4, H=2, C=4
MK-CPK42 ● Ø4.8, H=2, C=4
MK-WPK42 ● Ø5.5, H=2, C=4

MK-NPK43 ● Ø4, H=3, C=4
MK-CPK43 ● Ø4.8, H=3, C=4
MK-WPK43 ● Ø5.5, H=3, C=4

MK-NPK44 ● Ø4, H=4, C=4
MK-CPK44 ● Ø4.8, H=4, C=4
MK-WPK44 ● Ø5.5, H=4, C=4

MK-NPK61 ● Ø4, H=1, C=6
MK-CPK61 ● Ø4.8, H=1, C=6
MK-WPK61 ● Ø5.5, H=1, C=6

MK-NPC62 ● Ø4, H=2, C=6
MK-CPC62 ● Ø4.8, H=2, C=6
MK-WPC62 ● Ø5.5, H=2, C=6

MK-NPK62 ● Ø4, H=2, C=6
MK-CPK62 ● Ø4.8, H=2, C=6
MK-WPK62 ● Ø5.5, H=2, C=6

MK-NPC63 ● Ø4, H=3, C=6
MK-CPC63 ● Ø4.8, H=3, C=6
MK-WPC63 ● Ø5.5, H=3, C=6

MK-NPK63 ● Ø4, H=3, C=6
MK-CPK63 ● Ø4.8, H=3, C=6
MK-WPK63 ● Ø5.5, H=3, C=6

MK-NPC64 ● Ø4, H=4, C=6
MK-CPC64 ● Ø4.8, H=4, C=6
MK-WPC64 ● Ø5.5, H=4, C=6

MK-NPK64 ● Ø4, H=4, C=6
MK-CPK64 ● Ø4.8, H=4, C=6
MK-WPK64 ● Ø5.5, H=4, C=6

MK-CPK81 ● Ø4.8, H=1, C=8
MK-WPK81 ● Ø5.5, H=1, C=8

MK-CPK82 ● Ø4.8, H=2, C=8
MK-WPK82 ● Ø5.5, H=2, C=8

MK-CPK83 ● Ø4.8, H=3, C=8
MK-WPK83 ● Ø5.5, H=3, C=8

MK-CPK84 ● Ø4.8, H=4, C=8
MK-WPK84 ● Ø5.5, H=4, C=8



Burnout plastic cap,
anti-rotation



MN-ICH40
MD-ICH40
MW-ICH40

Burnout plastic cap,
free rotation



MN-IC040
MD-IC040
MW-IC040

Plastic healing cap

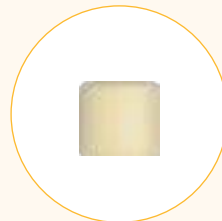

MM-CHC40
MM-CHC60
MM-CHC80

Transfer plastic cap

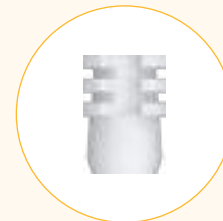

MN-IC600
MD-IC800
MW-IC800

Analogs

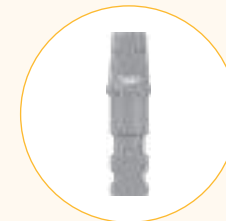

MN-RSM60
MD-RSM60
MW-RSM60

Overdenture
LOCKiT
 Attachment
 System

Tightening torque: 30 Ncm

i All LOCKiT products shown in this catalog are sold subject to individual regulatory certification only.

PLATFORM

SEVEN/M4
 NP

SEVEN/M4
 SP

SEVEN/M4
 WP

H1

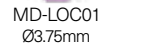
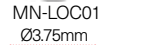
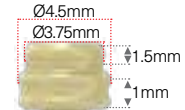
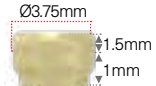

MW-LOC01

H2

MN-LOC02



MD-LOC02

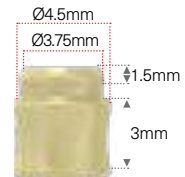

H3

MN-LOC03

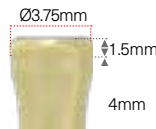

MD-LOC03



MW-LOC03

H4

MN-LOC04



MD-LOC04



H5

MN-LOC05

MD-LOC05

MW-LOC05

LOCKiT System Components



LOCKiT abutments
are also sold in kits

- MK-NLC1 ● Ø3.75, H=1
- MK-SLC1 ● Ø3.75, H=1
- MK-WLC1 ● Ø4.5, H=1
- MK-NLC2 ● Ø3.75, H=2
- MK-SLC2 ● Ø3.75, H=2
- MK-NLC3 ● Ø3.75, H=3
- MK-SLC3 ● Ø3.75, H=3
- MK-WLC3 ● Ø4.5, H=3
- MK-NLC4 ● Ø3.75, H=4
- MK-SLC4 ● Ø3.75, H=4
- MK-NLC5 ● Ø3.75, H=5
- MK-SLC5 ● Ø3.75, H=5
- MK-WLC5 ● Ø4.5, H=5

Core tool



MT-LOC10

Ratchet driver



MT-RSD19 - Short
MT-RSD24 - Long

Caps range



MM-BLA10
MM-RED10
MM-GRE10
MM-BLU10
MM-PIN10
MM-CLE10

Male processing
package



MM-LOC02

Metal housing



MM-TIT10

Impression coping



MM-LOC11

Analog



MM-LOA40 - NP/SP
MM-LOA50 - WP

Abutment holder sleeve



MT-LOC11

Overdenture
OT-Equators

Tightening torque: 30 Ncm

PLATFORM

SEVEN/M4
NP

SEVEN/M4
SP

SEVEN/M4
WP

H1



MK-NOE1



MK-SOE1



MK-WOE1

H2

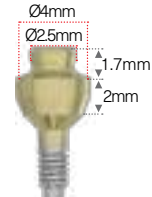

MK-NOE2

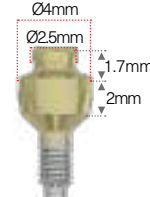

MK-SOE2

H3

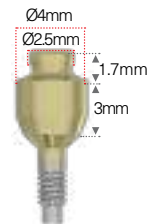

MK-NOE3

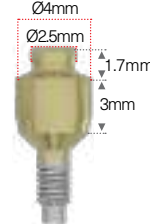

MK-SOE3

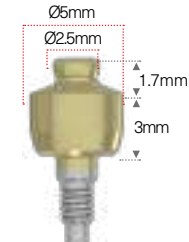

MK-WOE3

H4

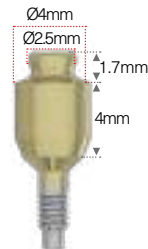

MK-NOE4

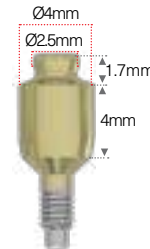

MK-SOE4

H5

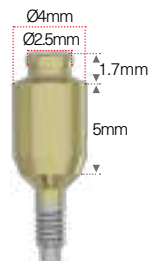

MK-NOE5

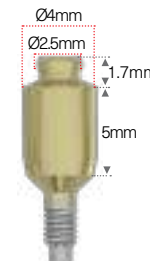

MK-SOE5

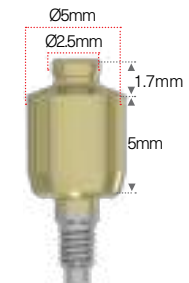

MK-WOE5

OT-Equators System Components

OT-Equators are sold in kits



Impression coping cap



OE-IC002

Analog



OE-RSM60

Metal housing and
transfer caps



OE-MH001
OE-RCB01
OE-RCY01
OE-RCP01
OE-RCW01
OE-RCV01

Handling tool



ET-IT002

Driver for 0.05 inch hex.



MT-RDS30 - Short
MT-RDL30 - Long

Overdenture
Ball
Attachment System

Tightening torque: 30 Ncm

PLATFORM :

H1

SEVEN/M4
NP



MB-N2330

SEVEN/M4
SP

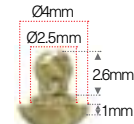

MB-N1375

SEVEN/M4
WP

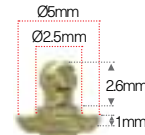

MW-B1500

ANGULATED
SP

H2



MB-N3330



MB-N2375

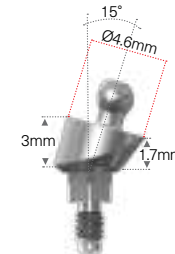

MB-AN152

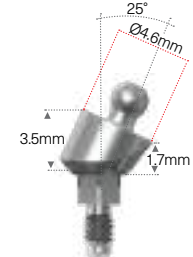

MB-AN252

H3



MB-N4330

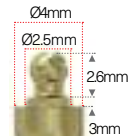

MB-N3375



MW-B3500

H4



MB-N4375

H5



MW-B5500

Ball Attachment System Components

Analog



MB-RS375

Titanium ball cap



MB-TTP10

Plastic mounting sleeve

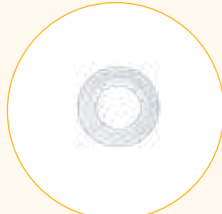

MB-PR010

Gold ball cap



MB-GPS10

Plastic ball cap



MB-SF200

Cap spring

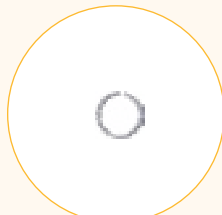

MB-TBS10

Cap spring

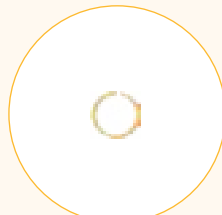

MB-TBS20

Standard plastic cap for metal housing



MB-PPC10

Soft plastic cap for metal housing



MB-PPR10

Plastic disc

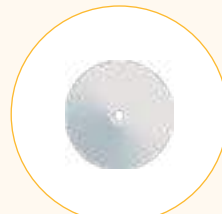

MB-DB235

Double metal housing



MB-DMH10

Ball attachment anchor key



MT-RB225

Prosthetic Screws and Drivers

Tightening torque: 20/30 Ncm

Prosthetic screw



MN-S0160 - NP
MD-S0220 - SP

Medium prosthetic
screw



MD-S0222

Long prosthetic screw



MD-S0224

Gold prosthetic screw



MD-G0220

Extra-short driver for 0.05
inch hex.



MT-RDM30

Short driver for 0.05 inch
hex.



MT-RDS30

Long driver for 0.05 inch
hex.



MT-RDL30

Extra-long driver for 0.05
inch hex.



MT-RDE30

Short motor adapter for
0.05 inch hex.

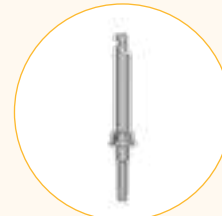

MT-SM005

Long motor adapter for
0.05 inch hex.

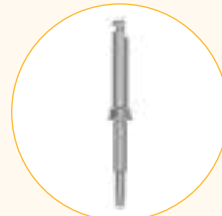

MT-LM005

Prosthetic Screws and Keys for Angled Screw Channel

Prosthetic screw for
angled screw channel*



MM-SA160

EZ-Base prosthetic screw



MN-E0160 - NP
MD-E0220 - SP

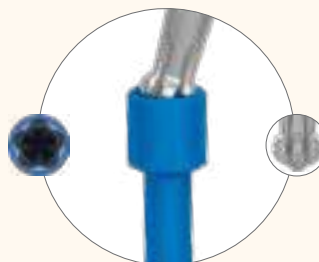

A unique screw and driver tip
design enable extreme angulation
and a wide insertion path.

Ratchet key for angled screw
channel



MT-ELR10 - Long
MT-ESR10 - Short

Motor key for angled screw
channel

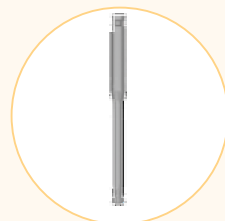

MT-ELM10 - Long
MT-ESM10 - Short

MK-0039
Prosthetic Tools Kit



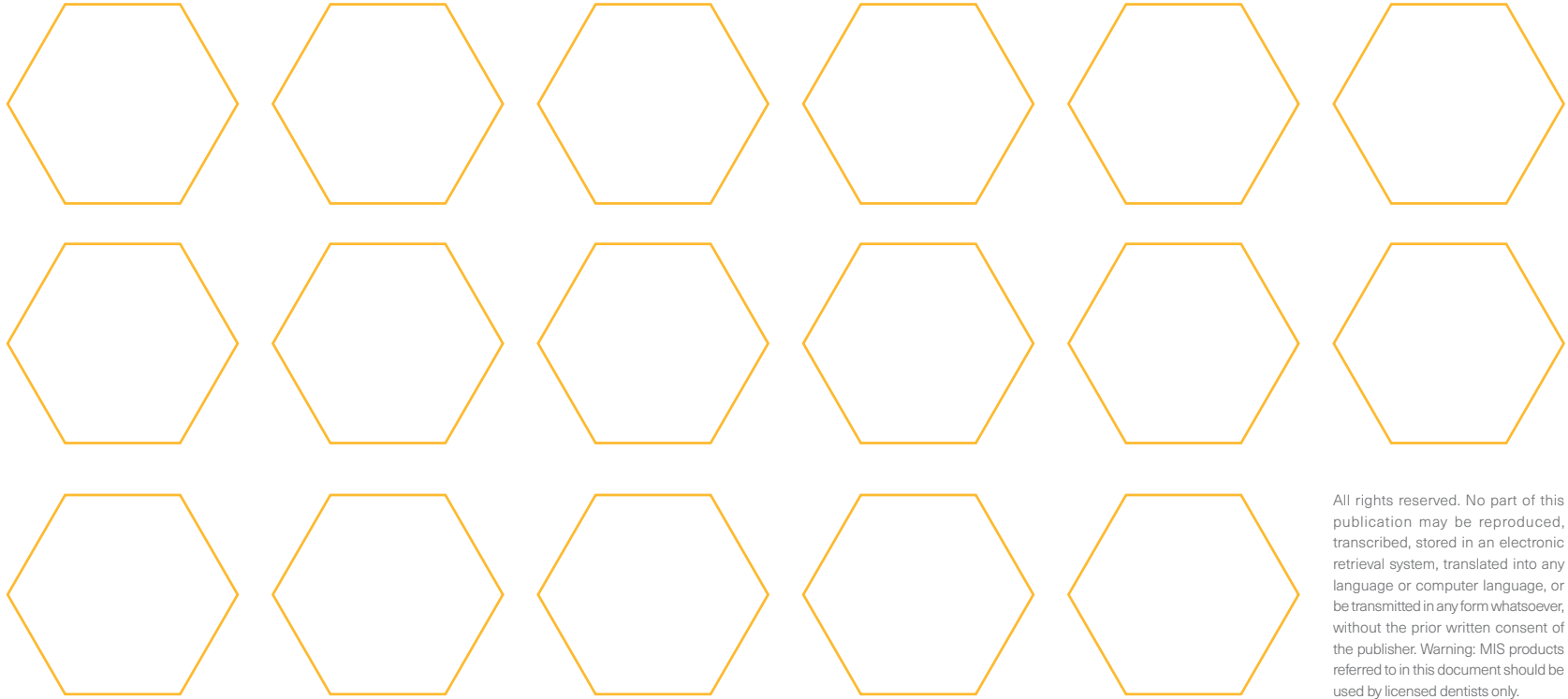

All rights reserved. No part of this publication may be reproduced, transcribed, stored in an electronic retrieval system, translated into any language or computer language, or be transmitted in any form whatsoever, without the prior written consent of the publisher. Warning: MIS products referred to in this document should be used by licensed dentists only.

Products may not be available in some regulated markets.
Please contact your local Dentsply Sirona sales office for current product assortment and availability.

